



*DM&P Group*

*eBOX-3800 EmbedBox*  
*eBOX-3850 EmbedBox*

***Easy On-line Compact PC***

## ***User's Manual***

*(Revision 1.0)*



## ● COPYRIGHT

The information in this manual is subject to change without notice for continuous improvement in the product. All rights are reserved. The manufacturer assumes no responsibility for any inaccuracies that may contain in this document, and makes no commitment to update or to keep current the information contain in this manual.

No part of this manual may be reproduced, copied, translated or transmitted, in whole or in part, in any form or by any means without the prior written permission of the DM&P Group

©Copyright 2005 DM&P Group  
Manual No. IUMEBOX3000-01 Ver.0.8

● Revised Date : Jun 24, 2005

● 1<sup>st</sup> Issued Date : May 13, 2005

## ● SPECIAL NOTICE TO USERS

DM&P GROUP PROVIDES NO WARRANTY WITH REGARD TO THIS MANUAL, THE SOFTWARE, OR OTHER INFORMATION CONTAINED HEREIN AND HEREBY EXPRESSLY DISCLAIMS ANY IMPLIED WARRANTIES OF MERCHANTABILITY OR FITNESS FOR ANY PARTICULAR PURPOSE WITH REGARD TO THIS MANUAL, THE SOFTWARE, OR SUCH OTHER INFORMATION. IN NO EVENT SHALL DM&P GROUP BE LIABLE FOR ANY INCIDENTAL, CONSEQUENTIAL, OR SPECIAL DAMAGES, WHETHER BASED ON TORT, CONTRACT, OR OTHERWISE, ARISING OUT OF OR IN CONNECTION WITH THIS MANUAL, THE SOFTWARE, OR OTHER INFORMATION CONTAINED HEREIN OR THE USE THEREOF.

DM&P Group reserves the right to make any modification to this manual or the information contained herein at any time without notice. The software described herein is governed by the terms of a separated user license agreement or label sticker.

This product contains software owned by DM&P and licensed by third parties. Use of such software is subject to the terms and conditions of license agreements enclosed with this product. Software specifications are subject to change without notice and may not necessarily be identical to current retail versions.

Updates and additions to software may require an additional charge. Subscription to online service providers may require a fee and credit card information. Financial services may require prior arrangements with participating financial institution.



## ● TRADEMARKS ACKNOWLEDGMENT

eBOX-III, eBOX-3800, and eBOX-3850 are the registered trademarks of DM&P Group

Microsoft®, Windows® and AMI are registered trademarks of Microsoft Corporation and American Megatrends, Inc. in the United States and/or other countries respectively.

Other brand names, product names or trade names appearing in this document are the properties and registered trademarks of their respective owners. All names mentioned herewith are served for identification purpose only.

## ● OWNER'S RECORD

The serial number of this product is located at the rear panel of your eBOX-III EmbedBox Compact PC series. Refer to the model and serial number when you contact your nearest dealer or DM&P offices for services. The Model No. of this product is also indicated on the product label of your gift box as: eBOX-3800 and eBOX-3850.



## ● SAFETY INFORMATION

### WARNING

- ▶ Do not expose your computer to rain or moisture, in order to prevent shock and fire hazard.
- ▶ Never install your computer in wet locations.
- ▶ Do not open the cabinet to avoid electrical shock. Refer to your nearest dealer for qualified personnel servicing.
- ▶ Never touch un-insulated terminals or wire unless your power adaptor and display monitor are disconnected.
- ▶ Locate your computer as close as possible to the socket outline for easy access and to avoid force caused by entangling of your arms with surrounding cables from the computer.
- ▶ When using eBOX-III, avoid using or installing the modem to the serial port during a storm or a lightning.
- ▶ Do not use the modem or a telephone to report a gas leak in the vicinity of the leak.
- ▶ USB connectors are not supplied with Limited Power Sources.

**DO NOT ATTEMPT TO OPEN OR TO DISASSEMBLE THE CHASSIS (ENCASING) OF THIS PRODUCT. PLEASE CONTACT YOUR NEAREST DEALER FOR SERVICING FROM QUALIFIED TECHNICIAN.**



## REGULATORY

### FCC CLASS A NOTE

This equipment has been tested and found to comply with the limits for a Class A digital device, pursuant to Part 15 of the FCC Rules. These limits are designed to provide reasonable protection against harmful interference when the equipment is operated in a commercial environment. This equipment generates, uses and can radiate radio frequency energy and, if not installed and used in accordance with the instruction manual, may cause harmful interference in which case the user will be required to correct the interference at his own expense. Testing was done with shielded cables. Therefore, in order to comply with the FCC regulations, you must use shielded cables with your installation.

### WARNING

This product Complies with EN55022 Class A. In a domestic environment this product may cause radio interference in which case the user may be required to take adequate measures.

Changes or modifications to this unit not expressly approved by the party responsible for compliance could void the user's authority to operate the equipment.

This device complies with Part 15 of the FCC rules. Operation is subject to the following two conditions: (1) this device may not cause harmful interference, and (2) this device must accept any interference received, including interference that may cause undesired operation.

This digital apparatus does not exceed the Class A limits for radio noise emissions from digital apparatus as set out in the interference - causing equipment standard entitled "Digital Apparatus", ICES-003 of the Department of Communications.

Cet appareil numérique respecte les limites de bruits radioélectriques applicables aux appareils numériques de Classe (A) prescrites dans la norme sur le matériel brouilleur: "Appareils Numériques", NMB-003 édictée par le ministre des Communications.

### MANUFACTURER'S DECLARATION OF CONFORMITY

This equipment has been tested and found to comply with the requirements of European Community Council Directives 89/336/EEC and 73/23/EEC relating to electromagnetic compatibility and product safety respectively.

### ATTENTION

This product has been designed and certified to comply with certain regulatory requirements pertaining to Information Technology Equipment. This product has not been designed for use as a medical device. Without limitation of the foregoing, this product is not intended and has not been certified for use in a hospital or clinical environment to diagnose, treat, or monitor patients under medical supervision, and is not intended and has not been certified to make physical or electrical contact with patients, nor to transfer energy to or from patients and/or to detect such energy transfer to or from patients.



# PURCHASE AGREEMENT

Version 1.1 – 2002/11/19

## **PURPOSE:**

In accordance to the general commercial conduct of Trust and Fair Trade, herewith below is the agreement for the protection for both parties, DM&P and Users in pursuant of trading.

## **PRODUCT DESCRIPTION :**

With this product, herewith also known as eBOX-III, which is a simplified & an economical design of an embedded computer for Special Purpose Personal Computing. The basic specification of this product comprises of the latest x86 technology design, and comes in 3 different speed version, which runs at a speed of 800MHz, with onboard 128MB System memory, Display, USB, Keyboard, PS2 Mouse, LAN, and Audio Interfaces.

## **DISTRIBUTION CONVENTION:**

1. This Product includes a Gift box, an inner case, a PC, a Power adaptor, User's Manual, Utilities & Drivers CD, and IDE cable (standard eBOX-III configuration do not have the IDE cable). Upon receiving this product, kindly please refer to the User' Manual to check for the contents and appearance of this product; contact immediately your nearest dealer or DM&P office for any defective or missing parts. The supplier will not be responsible for any reported discrepancy thereafter the expiration period of 3-days from the date of purchase.
2. In consideration of transportation and the cost of storage, the supplier provides to the distributors a warranty of 12-months. This warranty covers the failure caused by hardware breakdown (excluding hard drives), but does not cover the act of misuse and mishandling.
3. The supplier will not accept unknown post, therefore if you wish to repair or to return your goods – kindly please contact your nearest dealer to make your declaration, and at the same time, apply for a RMA number (RMA stands for Return Merchandise Authorization – please see the RMA form and fill-up for authorization).
4. The freight for Return goods for repair will follow the International customary practice and convention: Both parties is to pay for freight of one shipment each. The shipper is required to prepaid the freight from the place of origin (This means that the Returnee (user) covers the freight for return goods, while the Supplier covers the freight for goods after the repair).
5. Obsolete warranty is referred to as: (1)Expiration of warranty or (2)Damage due to misuse within warranty. The Supplier will be taken into consideration of the circumstances, to provide repair service with charges expense for obsolete warranty. This expense includes the cost of material and the cost of labor.

## **NOTE:**

If there is other particular issue not listed in the above conditions, both parties agreed to follow the General Law of Commerce with fair and reasonable discussion in handling and resolving the argument.



# Table of Contents

<u>CHAPTERS – HEADING</u>	<u>PAGE NO.</u>
0 – UNPACKING YOUR EMBEDBOX .....	1
▶ PACKING LIST .....	1
▶ CHECK BEFORE USE .....	1
1 – PREFACE .....	2
2 – eBOX-3800 OVERVIEW .....	3
eBOX-3850 OVERVIEW .....	4
3 – EMBEDDED CPU BOARD .....	5
▶ SYSTEM SPECIFICATION .....	5
4 – PERIPHERALS .....	6
▶ CONNECTING THE POWER ADAPTOR .....	6
▶ CONNECTING THE MONITOR .....	6
▶ CONNECTING THE USB .....	7
▶ CONNECTING USB, SPEAKER/EARPHONE & WEB .....	7
▶ CONNECTING THE KEYBOARD AND MOUSE .....	8
▶ CONNECTING PRINTER PORT .....	8
5 – BIOS .....	9
▶ RECONFIGURING eBOX-III .....	9
6 – TECHNICAL SPECIFICATION .....	10
▶ ORDERING INFORMATION .....	10
7 – TAKING CARE YOUR COMPUTER .....	11
▶ STORING .....	11
▶ USING CABLES FOR CONNECTION .....	12
▶ CLEANING YOUR COMPUTER .....	12
8 – TROUBLESHOOTING .....	13
▶ TROUBLESHOOTING YOUR EMBEDBOX.....	13
▶ COMPUTER DOES NOT START .....	13
▶ BIOS ERROR MESSAGE .....	13



▶ “OPERATING SYSTEM NOT FOUND” .....	14
<b>APPENDIX : ONBOARDCONNECTORS SUMMARY .....</b>	<b>15</b>
▶ <b>SUMMARY TABLE FOR CPU BOARD .....</b>	<b>15</b>
▶ <b>REAR CONNECTORS OUTLINE FOR eBOX-3800 .....</b>	<b>15</b>
▶ <b>REAR CONNECTORS OUTLINE FOR eBOX-3850 .....</b>	<b>16</b>
▶ <b>PIN ASSIGNMENTS .....</b>	<b>17</b>
<b>WARRANTY : TERMS AND CONDITION .....</b>	<b>19</b>
<b>1 WARRANTY .....</b>	<b>19</b>
<b>2 SERVICE AND SUPPORT .....</b>	<b>19</b>
<b>3 RETURN MERCHANDISE AUTHORIZATION (RMA) POLICY .....</b>	<b>19</b>
<b>4 SHIPPING POLICY .....</b>	<b>19</b>



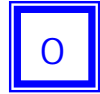

## UNPACKING YOUR EMBEDBOX

**Congratulation!** You have just acquire eBOX-III, the world's smallest and compact PC (See Figure 1), please check the following items:

### PACKING LIST FOR eBOX-3800 SERIES

Item	Description	Q'ty
①	eBOX-III EmbedBox Computer	x1
②	Max. 25-watts External Power Adaptor, Vin: 100~240VAC • 60/50Hz, 1.0A / Vout:: +5.0~5.25VDC @ 4A max. LPS	x1
③	Drivers CD for eBOX-III	x1
④	User's Manual	x1

\* Note: The accessories are subject to change without immediate notice.

### CHECK BEFORE USE



**Figure 1**



## PREFACE

### eBOX-III : EMBEDBOX EASY-ON-LINE COMPUTER



DM&P introduces an industrial classic in the computing industry, by featuring eBOX-III, a chef d'oeuvre compact PC that connects people through networking via global internet across the continents over the channels of sea bay. The conquest for browsing e-information through wired LAN/WAN. This portable device is handy for travelers and service technicians who worked in and out of the office. For office desk workers, this showpiece occupies very little space on a corner of the table, and it is so convenient that you may locked it in your drawer after office hours.

A jewel in the crown EmbedBox for thin client users, which is handy-rugged-robust. eBOX-III serves as the Internet Appliance that offers state-of-art design for applications surrounding networking, computing, transaction and information transport.

DM&P connotes the eBOX-III for small business enterprises to serve these boxes to users for the connection to a server as thin client. The EmbedBox achieves multi-servers requirement to serve as firewall, mail-server, print server, and many other single task application in the office. Furthermore, with eBOX-III, business executive can work his way from the office to home, a student can do his assignment from the dormitory and continue back at home. eBOX-III allows you to use your computer with just one finger press at the power button. It is built in an awesome mechanical dimension of 170×124×38mm(or 58mm), equivalent to 4.32"x3.15"x0.96"(or 1.47"), this is just a right device for space conscious environment.



## eBOX-3800 OVERVIEW

### Front Panel



#### Power LED

The power LED lights up, when system is turn on.

#### HDD LED

The HDD LED flashes when the system is working. Please do not turn off the system when HDD start running

#### Power Switch

Depress switch to turn on & turn off the systems.

#### USB port

For connection to devices with USB interface (keyboard, mouse, HDD, CD-ROM, Memory Stick, etc.)

### Back Panel



▶ Power switch

▶ DC Power Jack (3-pin)

▶ PS/2 Keyboard & Mouse (6-pin)

▶ PS/2 Mouse (6-pin)

▶ USB port

▶ RJ-45 LAN Jack

▶ VGA port

▶ Mic-in

▶ Audio Line out



# eBOX-3850 Overview

(('''



## Front Panel

### Power LED

The power LED lights up, when system is turn on.

### HDD LED

The HDD LED flashes when the system is working. Please do not turn off the system when HDD start running

### Power Switch

Depress switch to turn on & turn off the systems.

### USB port

For connection to devices with USB interface (keyboard, mouse, HDD, CD-ROM, Memory Stick, etc.)

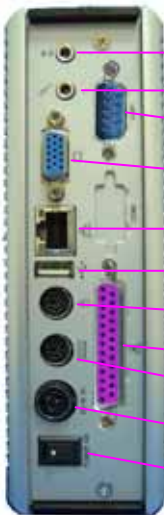

## Back Panel

▶ Audio Line out

▶ Mic-in

▶ Serial port \*\*

▶ VGA port

▶ RJ-45 LAN Jack

▶ USB port

▶ PS/2 Mouse (6-pin)

▶ Parallel port \*\*

▶ PS/2 Keyboard & Mouse (6-pin)

▶ DC Power Jack (3-pin)

▶ Power switch

\*\* This function is only available for eBOX-3850.



## ABOUT EMBEDDED CPU BOARD

### SYSTEM SPECIFICATION

#### CPU

VIA EDEN-N Nano 800MHz

#### North/South Bridge

VIA CLE266 + VT8235 Chipsets

#### Main Memory

128MB DDR266 ( Optional 256MB )

#### BIOS

"Plug and Play" function, auto-search new apparatuses inset.

Provide DMI for system management. Advanced ACPI configuration and power control interface. ( intelligence control system. )

#### VGA

AGP Rev.2.0 Compliant

Resolution up to 1,280x1,024 High Colors

#### Audio

AC97 CODEO, Fully Compliant with AC97 v2.2

#### LAN

10/100Base-Tx Ethernet Interface

#### Keyboard and Mouse

PS/2 Keyboard and Mouse

#### On-Board IDE

Support PIO, Bus Master, and Ultra DMA/66 operation.

Can connect to 2 IDE devices.

#### Peripheral

1. Printer port x1\*\*  
(support SPP/EPP/ECP module)

2. USB 2.0 ports x2

3. Serial port x1\*\*

4. Rear Audio(Mic-in, Line-out)

(\* This function is only available for eBOX-3850)

#### Dimension & Weight

eBOX-3800: 170 x 124 x 38 mm / 720g ;  
4.32 x 3.15 x 0.96" / 1.72 lbs

eBOX-3850: 170 x 124 x 58 mm / 920g ;  
4.32 x 3.15 x 1.47" / 2.07 lbs

#### Operating System

Suitable for –

Windows CE.NET

Windows XP Embedded

LINUX



## PERIPHERALS

### CONNECTING THE POWER ADAPTOR

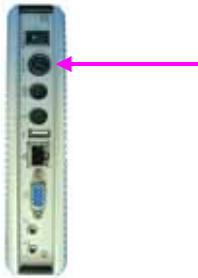

#### Power Adaptor

To use your computer immediately, take and use the supplied AC adaptor as a power source. See the left diagram for visual connection.

Connect the DC power jack of the power adaptor to the DC Input jack of eBOX-III.



#### Turning ON Your Computer

Press the power button as indicated on the figure on your left-side, the system will start automatically.

### CONNECTING THE MONITOR



#### VGA Connection

Depending on your choice of viewing, select a conventional CRT or the LCD VGA monitor.

Make your connection by following the reference diagram from the VGA cable of your cable to the 15-pin D-Sub VGA port of eBOX-III.



# PERIPHERALS

## CONNECTING THE USB

eBOX-III provides USB port (one each in front & at the back of the cabinet).

### Front cabinet



### Turning ON Your Computer

Press the power button as indicated on the figure on your left-side, the system will start automatically.

## CONNECTING USB, SPEAKER/EARPHONE AND WEB

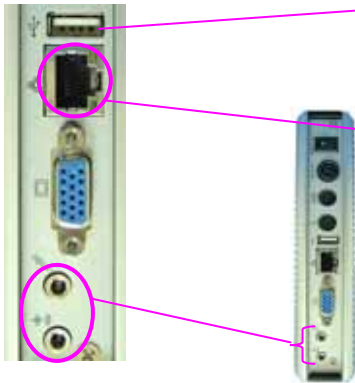

### USB Port

The second USB port is available for connection to USB devices.

### Connecting to WEB

There is an available RJ-45 LAN jack for connection to the hub of your intranet; and via your server for internet service (see diagram for RJ-45 LAN jack).

### Speaker/Earphone

eBOX-III supports Input/Output device for speaker, earphone and MIC (Microphone), etc...



## CONNECTING THE KEYBOARD AND MOUSE



### Describing Mouse actions

#### Action

#### Description

Point

- Slide and point your mouse to your desired position.

Click

- Press the left button once.

Double-click

- Press the left button twice.

Right-click

- Press the right button once. When selecting (most) programs, this action displays a shortcut menu of the context-sensitive choices.

Scroll wheel

- Move your finger along the wheel of your mouse (just upright your middle finger) and scroll vertically to move page upward and downward.

### Describing Keyboard

The keypad usually comes in standard QWERTY; except that different language(s) keyboard comes with additional special characters..

## CONNECTING PRINTER PORT

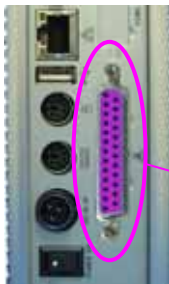

### Printer Port

The printer port is usually connected to a Printer for printing hardcopy materials. It is normally idle most of the time.



## BIOS

### RECONFIGURING eBOX-III

1. Take note that AMI BIOS is used in the eBOX-III Compact PC. To reconfigure the computer, depress or hit the <Del> key to enter your BIOS setup main menu.
2. Select from the menu, the desired setup for change.
3. Press <Esc> to go back to main menu.
4. Move your cursor to "Save Settings and Exit", press "Y" to save the changes that you just made. eBOX-III will restart accordingly to your new setup.



## TECHNICAL SPECIFICATION

Features	Description
CPU	Onboard VIA EDEN-N Nano BGA processor 800MHz
BIOS	AMI BIOS
System Chipset	VIA CLE266 / VT8235
I/O Chip	VT1211
System Memory	Onboard 128MB DDR266 (optional 256MB)
Expansion	1x X-PCI connector
<b>I/O</b>	
MIO	1x EIDE (Ultra DMA 133), 1 x LPT, 1 x RS-232**, 1x PS/2 K/B, 1 x PS/2 Mouse
USB	2x USB 2.0 Ports (one in front)
<b>Display</b>	
Chipset	Integrated VIA UniChrome 2D/3D Graphics with MPEG2 Accelerator
Display Memory	8/16/32 MB share system memory
Resolution CRT	CRT mode : 1280 x 1024 @32 bpp (85Hz) LCD/Simultaneous mode : 1280 x 1024 @ 32 bpp (85Hz)
<b>Audio</b>	
AC97 2.2 (Codec)	VT1612
Audio Interface	Line out, Line in, Mic in
<b>Ethernet</b>	
Chipset	VT6103 10/100 Base-T
Remote Boot ROM	Built-in boot ROM function
<b>Mechanical &amp; Environment</b>	
Power Requirement+	5V~5.25V @ 4A (with VIA Eden-N 800Mhz, 256MB DDR266 & Laptop HDD)
Operating Temperature	0 ~ 60°C (32 – 140°F)
Operating Humidity	0 ~ 90% relative humidity, non-condensing
Size (W x H x D)	eBOX-3800 : 170 x 124 x 38 mm / 4.32 x 3.15 x 0.96" eBOX-3850 : 170 x 124 x 58 mm / 4.32 x 3.15 x 1.47"
Weight (3800/3850)	720g / 920 g



## TAKING CARE YOUR COMPUTER

This section gives you guidelines on using eBOX-III computer – Safe using, Storing and Handling.

### STORING

- ▶ Do not place your computer in a location that is subject to:
  - Heating sources, such as stove, oven, heater, radiator or air duct
  - Direct contact from sunlight
  - Rain or moisture area
  - Excessive dust accumulation area
  - High humidity place
  - Constant or occasional mechanical movement, vibration or shock
  - Strong magnets or magnetic fields or magnetically unshielded speakers
  - Ambient temperature of more than 95°F (35°C) or less than 32°F (0°C)
- ▶ Do not place other electronic device or electrical equipment near your computer. The electromagnetic field of the computer may cause interference subjecting to malfunction.
- ▶ Provide adequate air ventilation (circulation) to prevent internal buildup of heat. Do not place your computer near the wall, behind the curtains or draperies, in between two books that block its ventilation slots. Leave a space of at least 8 inches (20cm) behind the sides and back panel of the computer.
- ▶ Change of environmental temperature: Problems may occur when there is a sudden change of environmental temperature, or if the computer is brought directly from a cold location to a warm one, moisture may condense inside your computer. Turn off your computer, and contact your nearest dealer.
- ▶ Checking the surrounding appliance(s) before using your computer. Since the computer uses high-frequency radio signal and may interface with radio or TV reception causing interference or poor signal display. When this happens, relocate the computer by a suitable distance away from the set.
- ▶ Do not drop the computer from the working table nor place heavy objects on top of the computer.



## USING CABLES FOR CONNECTION

- ▶ To avoid problem, use only the specified interface cables in your accessory bag. The supplier will not be responsible for the connection arising from the other unspecified peripheral equipment.
- ▶ Do not use cut or damaged cables for connection.

## CLEANING YOUR COMPUTER

- ▶ Clean the computer with a soft, dry cloth or a soft cloth lightly moistened with a mild detergent solution.
- ▶ Do not use any type of abrasive pad, scouring powder, or solvent such as alcohol or benzine, as these may damage the finish of your computer.
- ▶ When a solid object falls or a liquid spills onto the computer, turn off the computer immediately and unplug the LAN and power cables. Contact a qualified person or your dealer to check the computer before you use it again.
- ▶ Always disconnect the power cord from the power source before cleaning the computer.



## TROUBLESHOOTING

This section describes the techniques of resolving some basic problems that you encounter when using your computer. For more troubleshooting guidelines, please contact your nearest dealer for technical support.

### TROUBLESHOOTING YOUR EMBEDBOX

#### A. Computer does not start

- ▶ Make sure the computer is properly secured and plugged into a power source before it is turned on. Make sure the power indicator shows the power is on. See section 2 for more information about “eBOX-3800 Overview” & eBOX-3850 Overview.
- ▶ When the computer is plugged into a power strip or the UPS (Uninterruptible Power Supply), make sure the power strip or UPS is turned on and working normally.
- ▶ Check if your VGA or LCD monitor is properly plugged into a power source and turned on. Make sure the brightness and contrast controls are adjusted correctly. See the manual that came with your display (monitor) for details.
- ▶ Check if your power control button does not function, by removing the AC adaptor. Wait for one minute, and then reattach all power connection before pressing the power button.
- ▶ Condensation may cause the computer to malfunction for a while. If this happens, do not use the computer for at least one hour.
- ▶ When you have checked all the above guidelines and the computer does not work. Remove the power adaptor from the computer, unplug the power cord, and plug it in again. Then turn on the power.

#### B. BIOS Error Message –

##### BIOS error message appear when my computer starts

If the BIOS error message appears, press any key to resume or, hit <DEL> to enter BIOS setup main menu, follow these steps:

1. Press <DEL>, and the **BIOS Setup main menu** appears, check if HDD is detected at “Pri Master”. If it is not detected, use “Sel” keys < > to choose “**AUTO**”, then go back to the main menu by pressing <ESC>. Move your cursor down with “Sel” keys < >, and choose “Save Settings and Exit”, a message dialog appears as seen below, hit <Enter>.

“Save current settings and exit (Y/N)? Y”



2. Go to "Auto Configuration with Optimal Settings" using the "Sel" keys < >, then press <Enter>. A message dialog appears as seen below, hit " Y " key and press <Enter> to save and recover the factory setting.

"Load high default settings (Y/N)? N "

### C. "Operating System Not Found" –

A message indicating that "Operating system not found" appear when my computer starts (Windows won't start)

- ▶ Enter your BIOS setup main menu by pressing <DEL> key, be sure that your C: drive is enable.
- ▶ If Windows still does not start, follow these steps to initialize the BIOS:
  1. Turn off the computer.
  2. Remove any peripheral devices connected to the computer.
  3. Restart the computer..
  4. Press <DEL> to enter **BIOS Setup main menu** window.
  5. Follow the steps as written in item B. **BIOS error message**.
- ▶ **For eBOX-III** : If you have just connect your computer to a CDR or Floppy disk, remove these peripherals.. And restart your computer to confirm that the Windows operating system starts properly. If your computer continues to display the message "Operating system not found," and Windows does not start, please contact your nearest dealer for servicing.



ONBOARD CONNECTORS SUMMARY

SUMMARY TABLE FOR CPU BOARD

Nbr	Description	Type of Connections	Pin nbrs.
J1:	LAN	RJ-45 FOXCONN	8-pin
J2:	IDE Connector	Box Header, 22x2-2.0mm	44-pin
J3:	VGA Connector	D-Sub Connector	15-pin
J4:	USB1 (Front)	USB 90° Type1 Connector	8-pin
J5:	USB (Back)	USB Type1 Connector	6-pin
J6, J7:	PS/2 Keyboard & Mouse	Mini-Din Connector 6P	6-pin
J8	PRN (Printer)	Box Header, 13x2-2.0mm	26-pin
J9:	COM1 /RS-232	Pin Header, 5x2-2.0mm	10-pin
J11, J13:	Line-Out, MIC	Two contact Switch	6-pin
J12, J19:	Line-In, SB5V	Wafer Header 4-2.0mm	4-pin
J15:	RST (Reset)	Header 2x1-2.0mm	2-pin
J16:	Fan	Wafer Header 2-2.0mm	2-pin
J17:	DC 5V Input	Mini-Din Connector 3P	3-pin
J18:	X-PCI	Header 32x2-2.0mm	64-pin
SP1:	Buzzer		2-pin

► REAR CONNECTORS OUTLINE FOR eBOX-3800

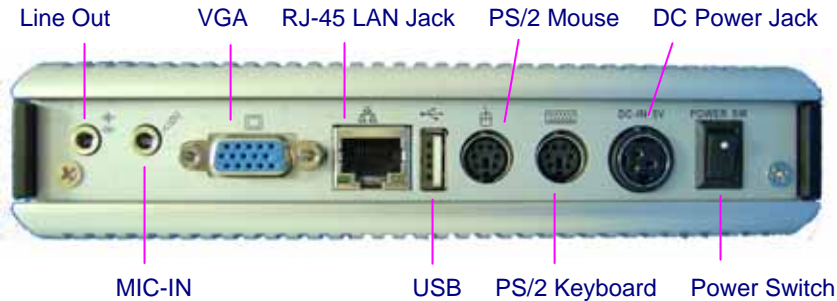

► REAR CONNECTORS OUTLINE FOR eBOX-3850

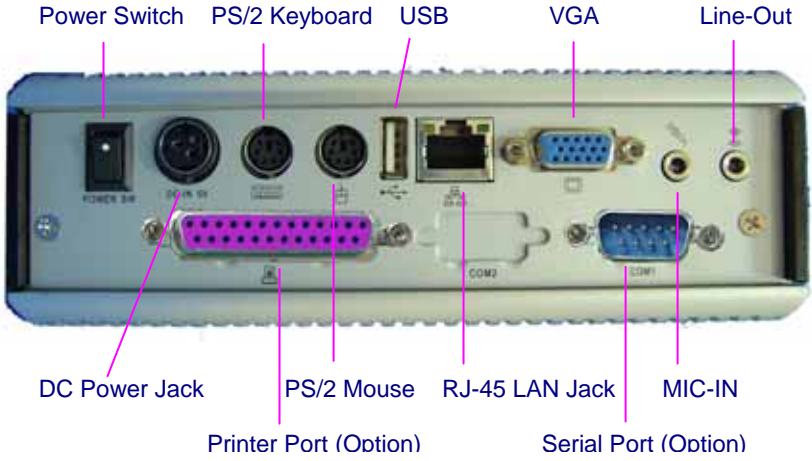

## ► PIN ASSIGNMENTS

J6:KBD(PS/2Keyboard & Mouse) – 6-pin Mini-Din Connector

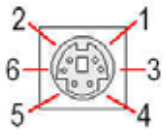
	Pin #	Signal Name
	1	KBCLK
	2	PMCLK
	3	GND
	4	KBDAT
	5	PMDAT
6	SB5V	

J7: Mouse (PS/2 Mouse) – 6-pin Mini-Din Connector

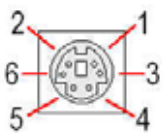
	Pin #	Signal Name
	1	PMCLK
	2	NC
	3	GND
	4	PMDAT
	5	NC
6	SB5V	

J1: RJ-45 FOXCONN (LAN)– 12-pin RJ45 Connector

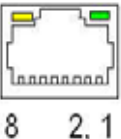
	Pin #	Signal Name	Pin #	Signal Name
	1	FTXD+	2	FTXD-
	3	FRXIN+	4	NC
	5	NC	6	FRXIN-
	7	NC	8	NC

J8 : Printer- 25-pin Dsub Connector

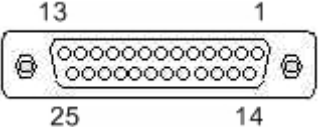
	Pin #	Signal Name	Pin #	Signal Name
	1	STB-	14	AFD-
	2	PD0	15	ERR-
	3	PD1	16	PRINIT-
	4	PD2	17	SLIN-
	5	PD3	18	GND
	6	PD4	19	GND
	7	PD5	20	GND
	8	PD6	21	GND
	9	PD7	22	GND
	10	ACK-	23	GND
	11	BUSY	24	GND
	12	PE	25	GND
13	SLCT	-	-	

Power Sw – Push Button Switch

	Pin #	Status
		ON
	0	OFF

J17: DC-IN (DC-IN 5V) – 3-pin MINI-DIN Lock Pin Socket

	Pin #	Signal Name
	1	VCC
	2	GND
	3	NC

J4: USB1 (USB1x90°)– 4-pin USB Type 1 Connector (Vertical Type)

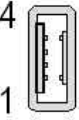
	Pin #	Signal Name
	1	VCC
	2	USB0-
	3	USB0+
	4	GND
	5	GGND
	6	GGND



## ► PIN ASSIGNMENTS

J3: VGA – 15-pin Dsub Connector

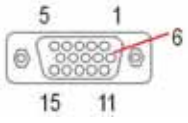
	Pin #	Signal Name	Pin #	Signal Name	Pin #	Signal Name
	1	MR	6	GND	11	NC
	2	MG	7	GND	12	VCC
	3	MB	8	GND	13	HYSYNC
	4	NC	9	NC	14	VSYNC
	5	GND	10	GND	15	VCC

J11: MIC\_IN – 5-pin RCA Phone Jack

	Pin #	Signal Name
	1	GND
	2	AUD MIC
	3	GND
	4	GND
5	REF	

J5:USB (USB2): For connection to external USB device –4-pin USB Type 1 Connector (H)

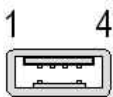
	Pin #	Signal Name
	1	VCC
	2	USB2-
	3	USB2+
	4	GND
	5	GGND
6	GGND	

J13: Line-out – 5-pin Phone Jack

	Pin #	Signal Name
	1	GND
	2	LOUT L
	3	NC
	4	NC
5	LOUT R	

SW1:Reset – 2-pole Push button switch

	Action	Status
	Push	ON / OFF

LEDS: POWER ON/OFF & HDD R/W

	LED Color	State
	Green	Power On
	Red Flashes	HDD R/W

J9: COM1 - 9-pin Dsub Connector

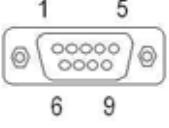
	Pin #	Signal Name	Pin #	Signal Name
	1	DCD1	2	RXD1
	3	TXD1	4	DTR1
	5	GND	6	DSR1
	7	RTS1	8	CTS1
	9	RI1	--	--



## TERMS AND CONDITIONS

### 1. Warranty

The warranty terms for eBOX-III is twelve (12) months from the beginning on the date of invoice. During the warranty period, DM&P Group Will repair replace the product covered under this limited warranty.

### 2. Service and Support

DM&P Group provides the technical support for hardware problems with your system throughout the warranty period. The technical support service is limited to configuration and operation of eBOX-III sold by DM&P Group. The technical support service does not offer software tutoring or training.

### 3. Return Merchandise Authorization ( RMA ) policy

If the DM&P staff or dealer determines that a part is defective. Purchaser must call our technical support service to obtain an RMA number before attempting to return any part. Please refer to your nearest dealer for

To obtain an RMA number, Purchaser must follow procedures as below :

1. Complete the DM&P Group standard RMA Form and fax back to the RMA Department.
2. The RMA Number must be used within 7 DAYS
3. The RMA Number must be shown clearly on your shipping label.
4. DM&P Group must receive all Returns before a replacement will be sent.
5. The repair cost is depends on the parts, the damage reasons, and whether under warranty period...etc. The Seller will charge the Purchaser in a reasonable price.
6. A copy of the invoice for the RMA product(s) will also be shipped to Purchaser.
7. The freight of return to Media Stream Tech. is charges to Purchaser account and accompanied by an RMA number. Any Returns with freight collect will be refused and returned to you. After Repairing, the cost of freight will be paid by Seller.
8. DM&P Group must receive all returned goods within the warranty period.

### 4. Shipping Policy

The Purchaser must pre-pay shipping for any defective system or parts returned under the warranty. DM&P Group shall not be liable for risk of loss or damage during shipment of your returned system or parts if you fail to insure the shipment.

All products must be shipped back to DM&P Group in original or equivalent packaging. DM&P Group will ship the repaired or replacement product(s) to Purchaser by freight prepaid. Purchaser assumes the risk of loss. DM&P Group shall not be responsible for failure of the delivery service to make on-time delivery.



# MEMO

---

